



Spolufinancovaný
Európskou úniou

ERAZMUS + Vitalis Gut Wehlitz

29. 10. 2023 – 11. 11. 2023

Our journey



We travelled by a train

- From Trenčianska Teplá to Bratislava
- From Bratislava to Dresden
- From Dresden to Leipzig
- From Leipzig to Schkeuditz West

INTRODUCTIONS

On our first day they explained to us where everything was.

We learnt the rules we had to follow and where we could find the informations for the following days.

Later in the afternoon we met with our mentors and they explained to us what we will be doing for the two weeks.

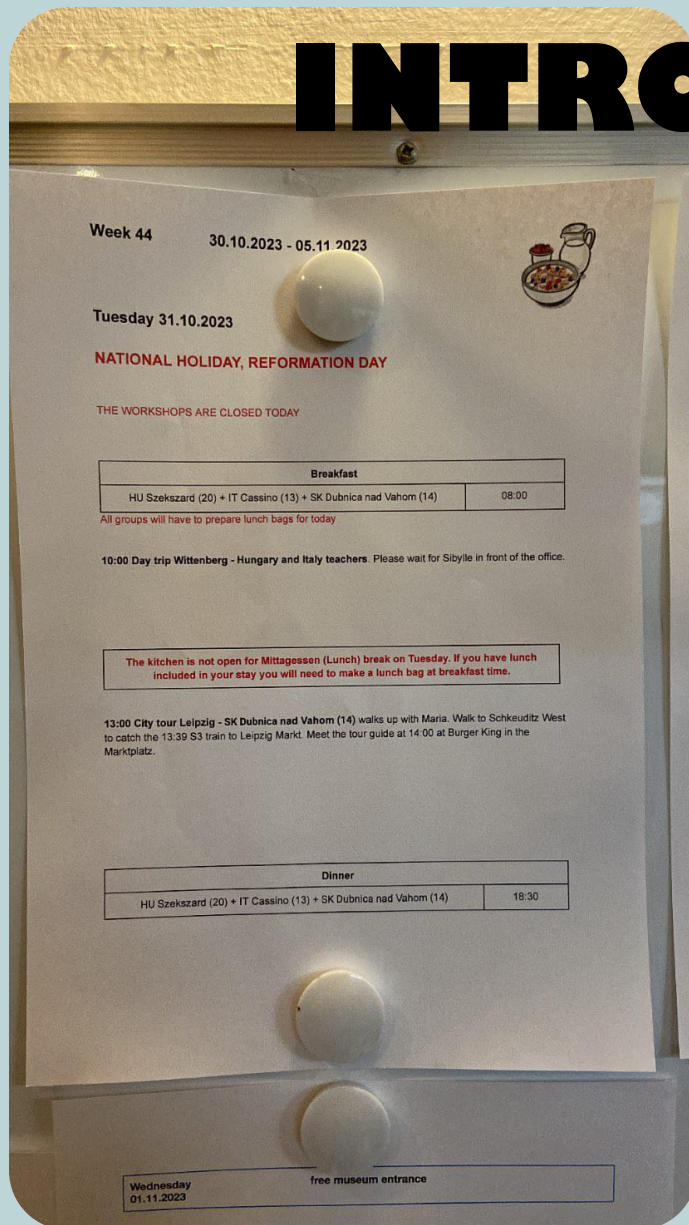

Leipzig

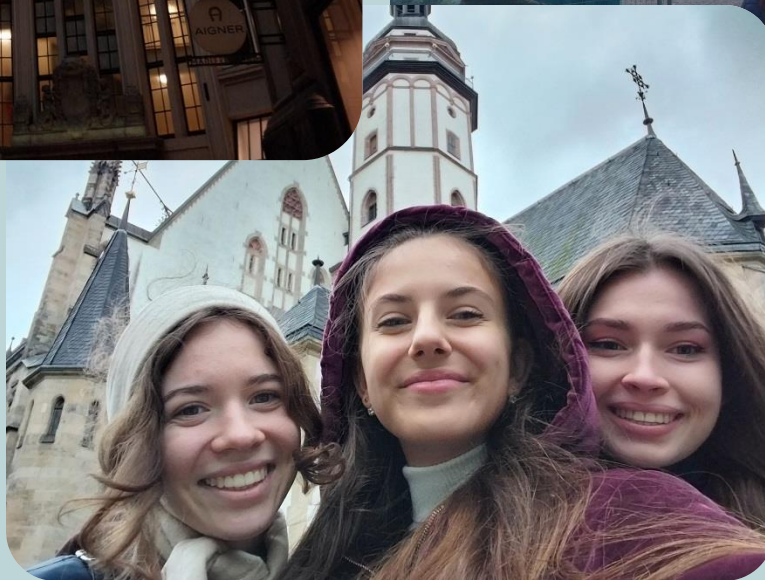

We visited the city of Leipzig, where we went sightseeing

Workshop

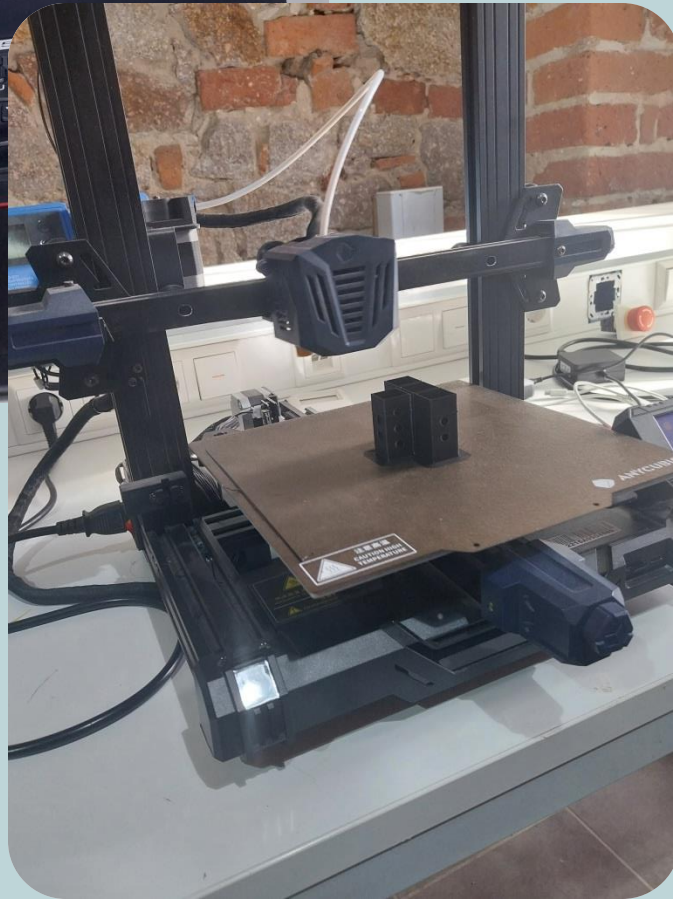
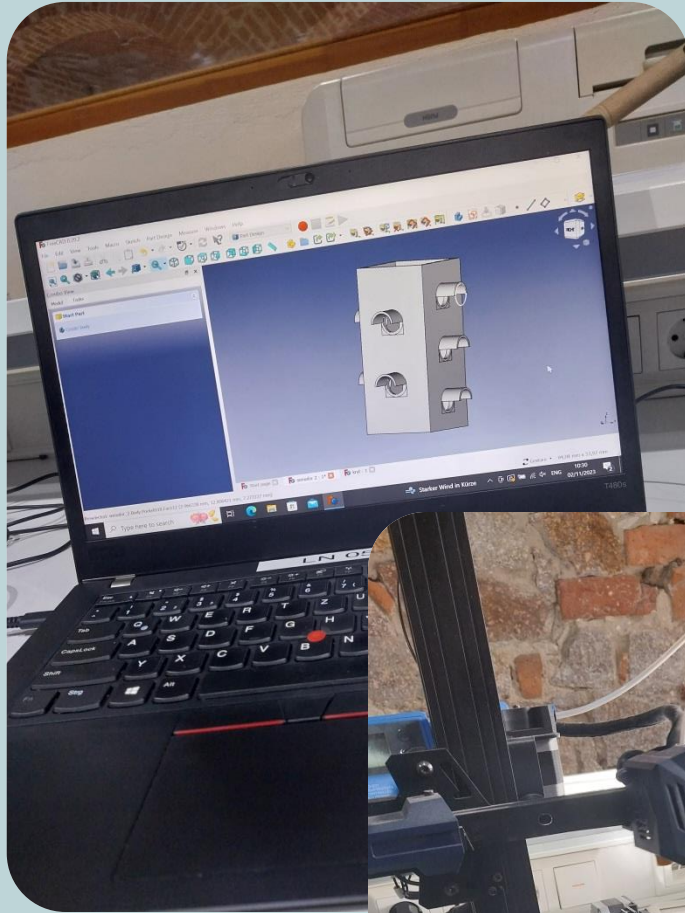

We took measurements of the traffic light and started desinging it ina a program called FreeCAD.

When we had our finished desings we exported them to Ultimaker Cura and than we put it in the 3D printer. After calibrating the 3D printer we just pressed start.

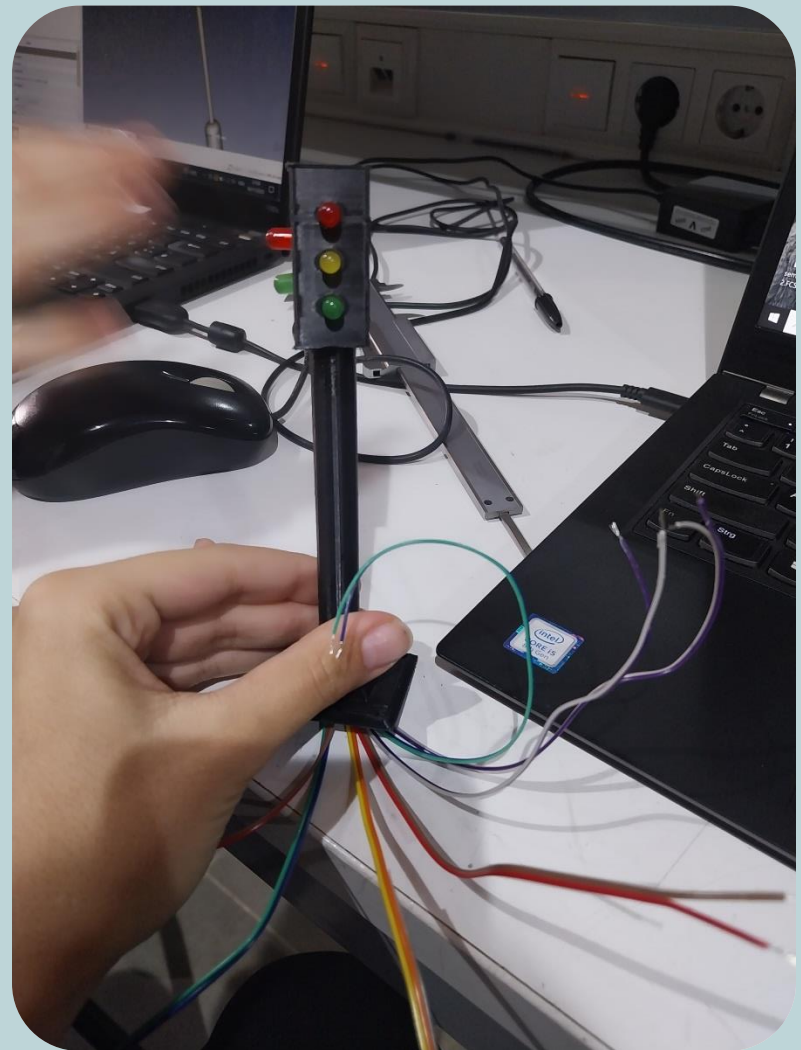
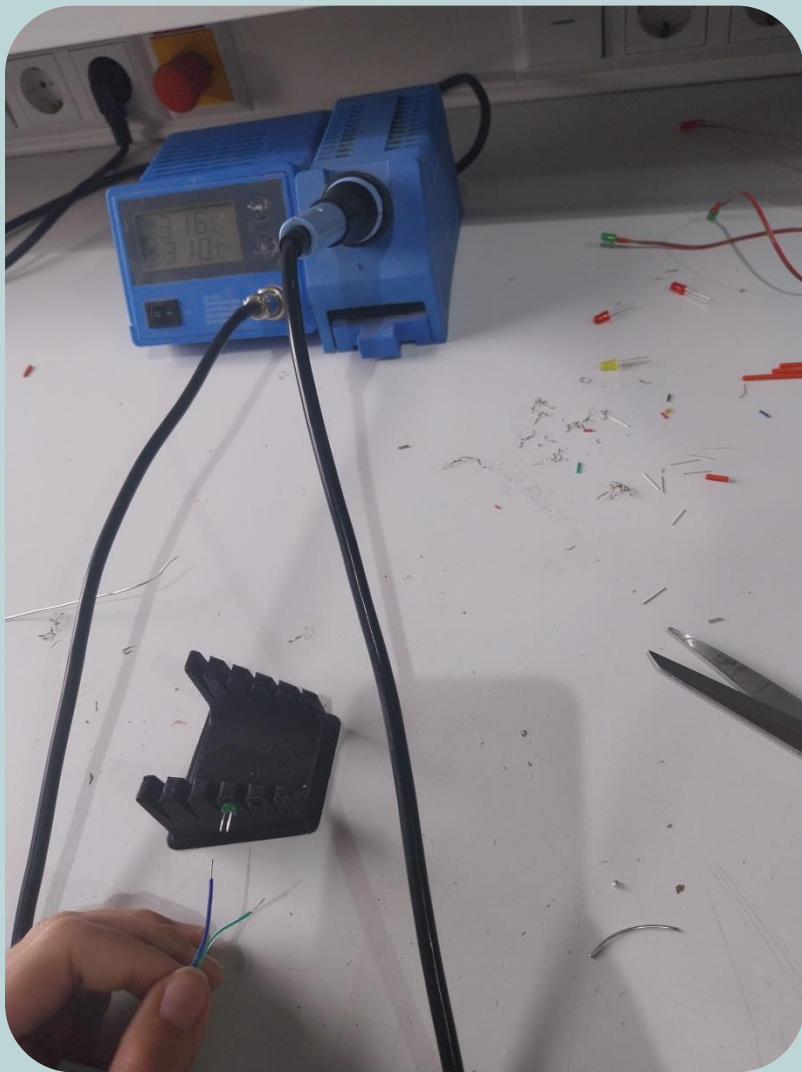

We also learnt how to solder and after soldering all of the diodes we put them in our printed traffic light.

The next day we designed pcb boards in a program called EasyEDA. When it was finished we put it in the laser engraver.

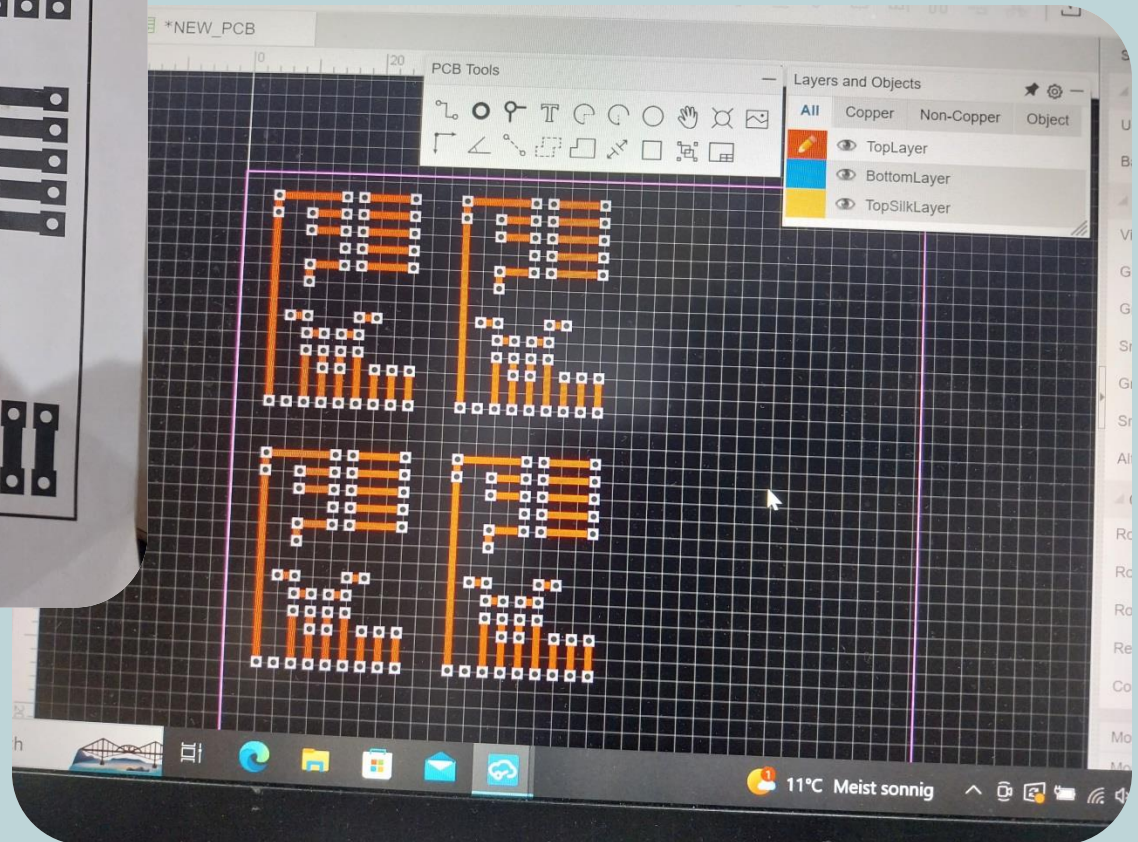
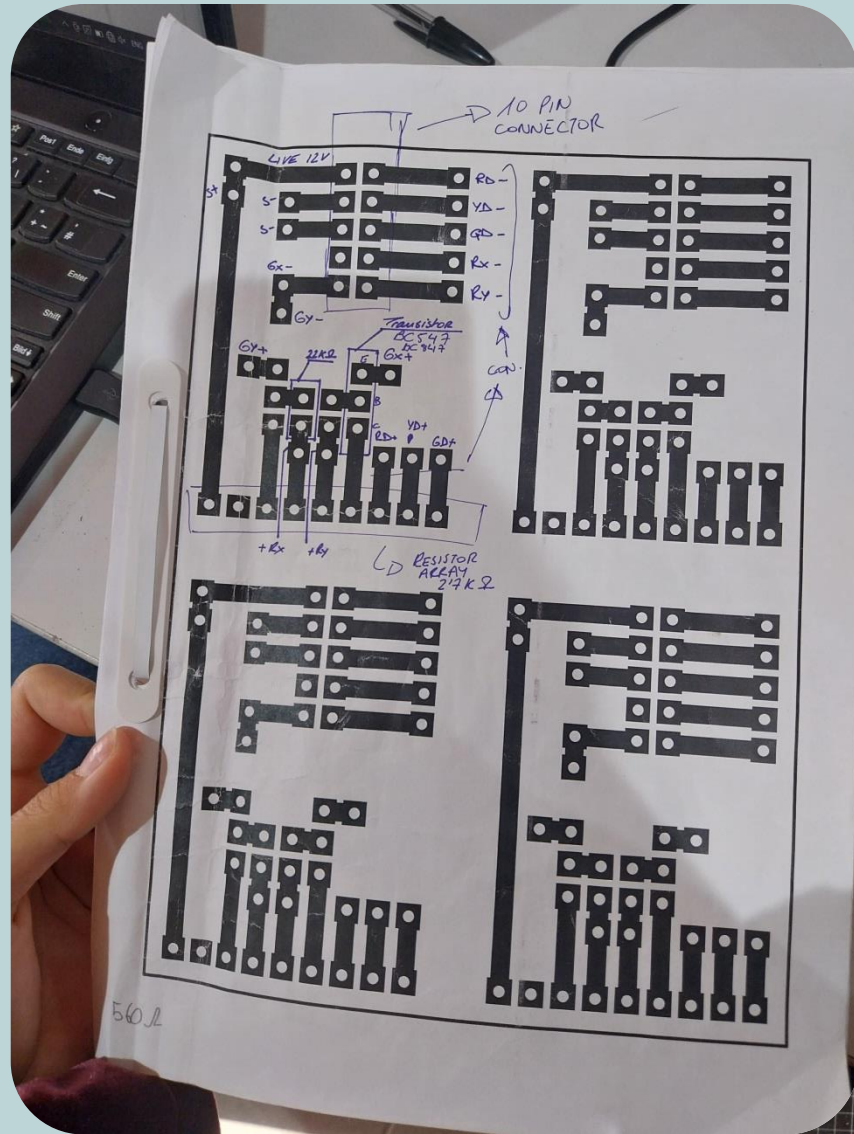

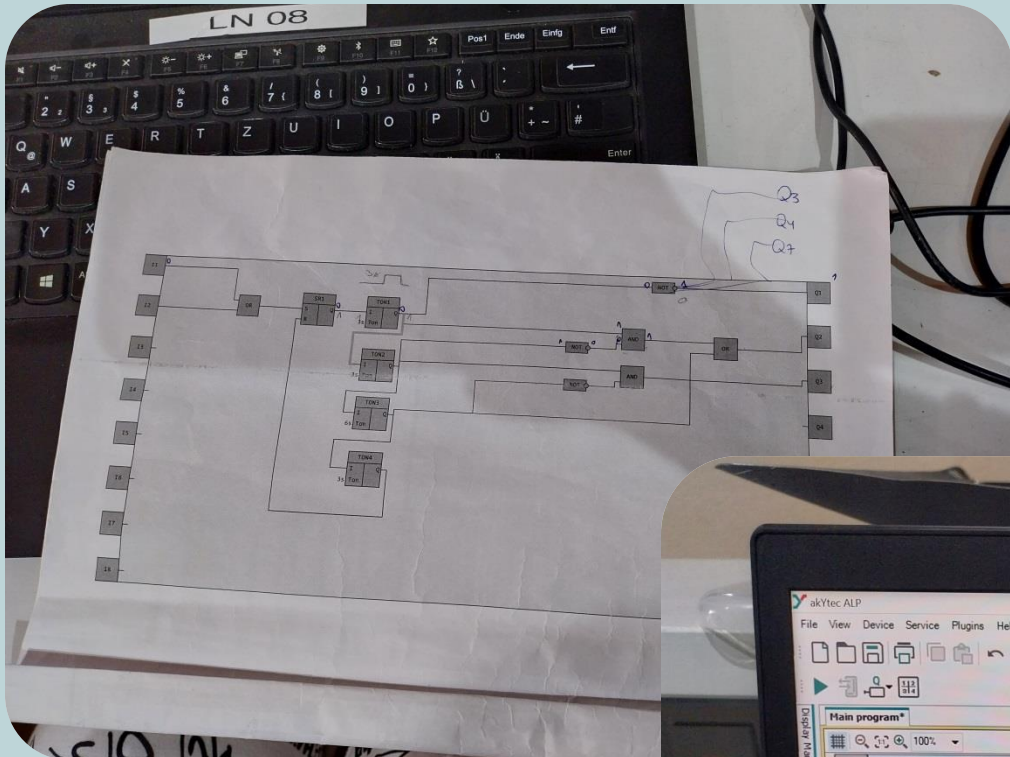

Then using a program called akYtec ALP we programmed which traffic light will shine and when, so that the intersection could work properly.

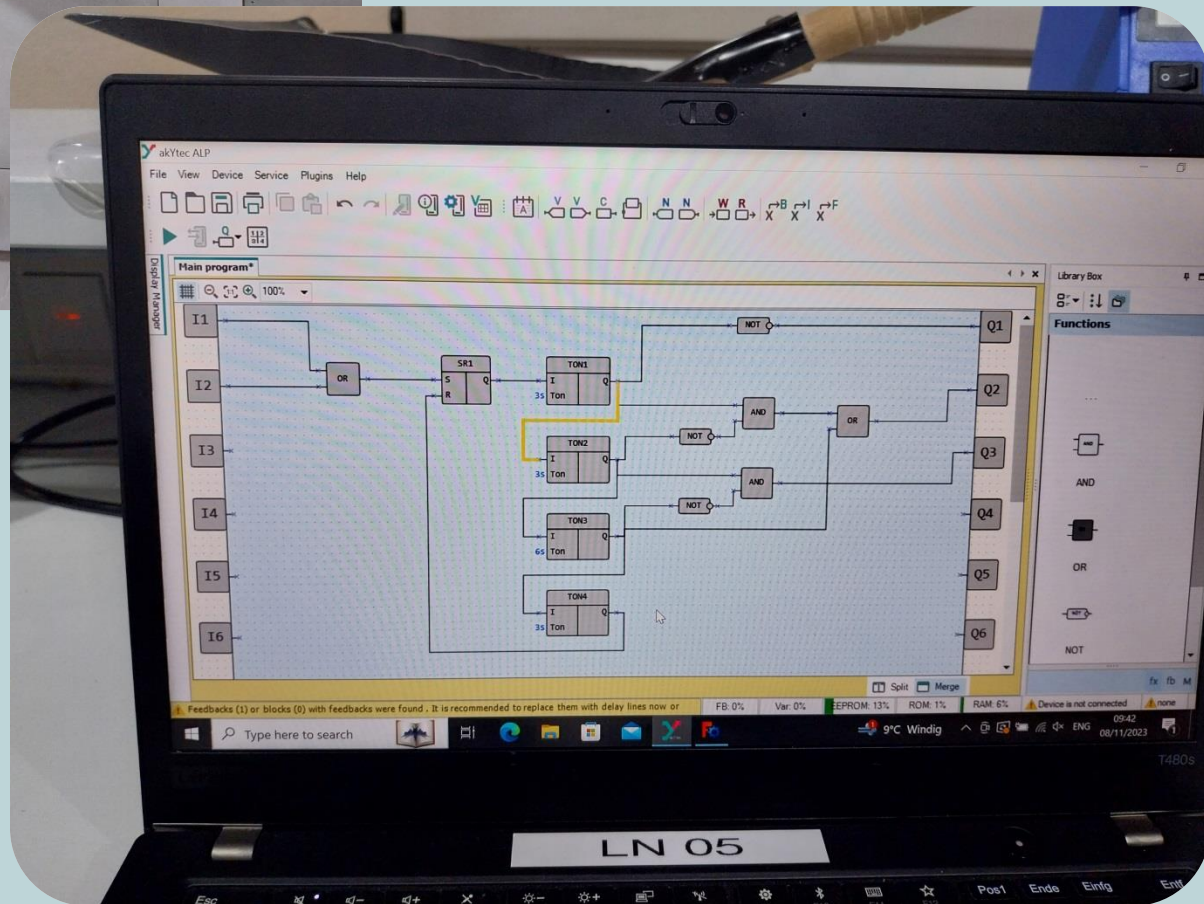



We put our finished traffic lights on a wooden board and this is how the looked.

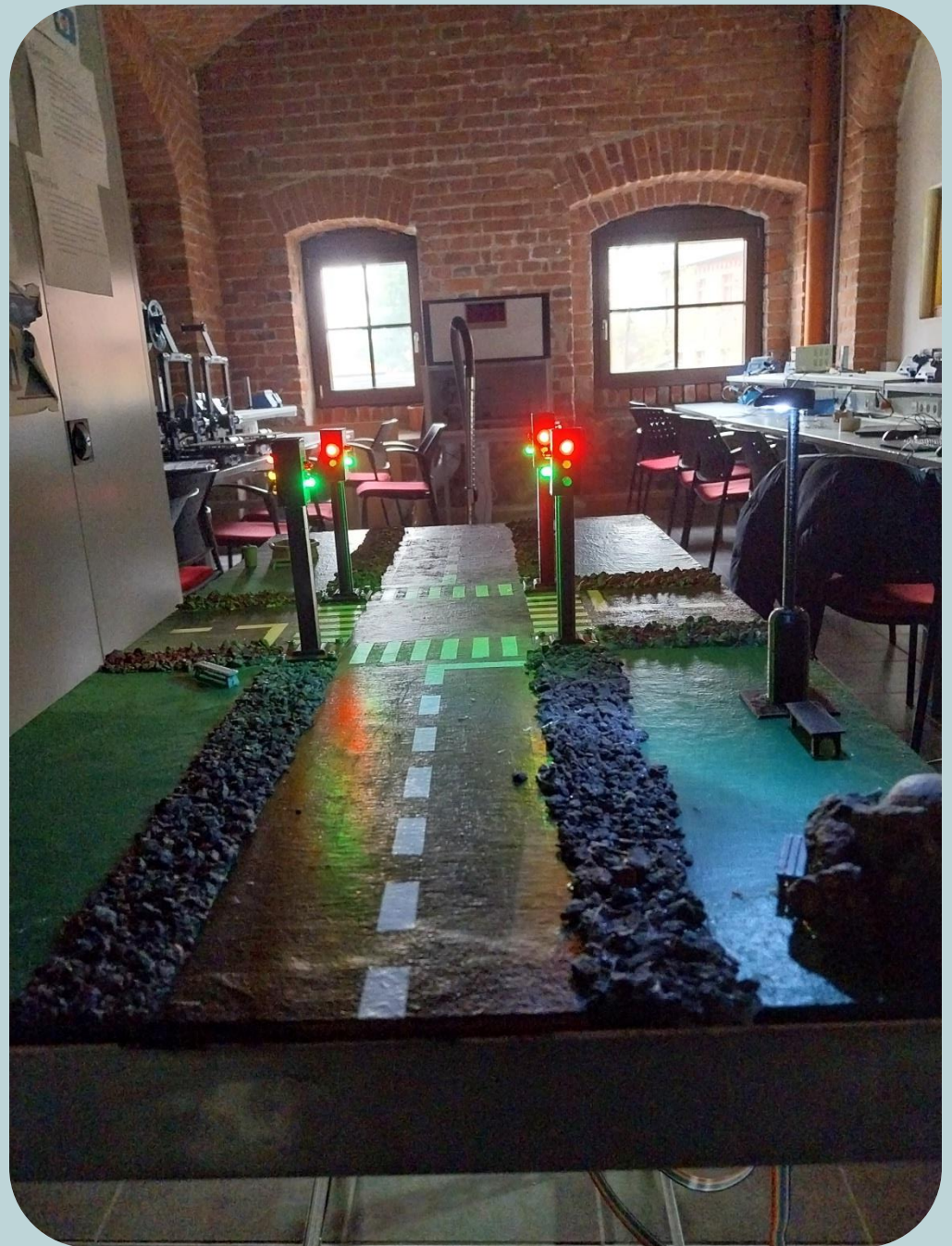

Dresden

Our trip to Dresden, where we saw a lot of historical places.

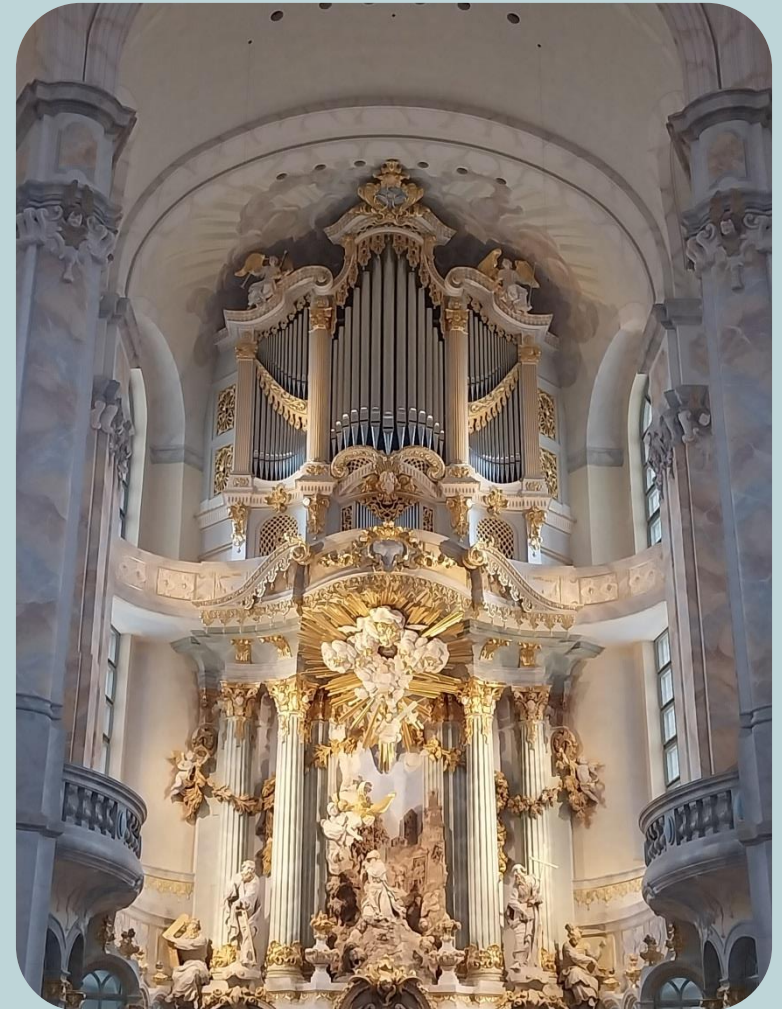
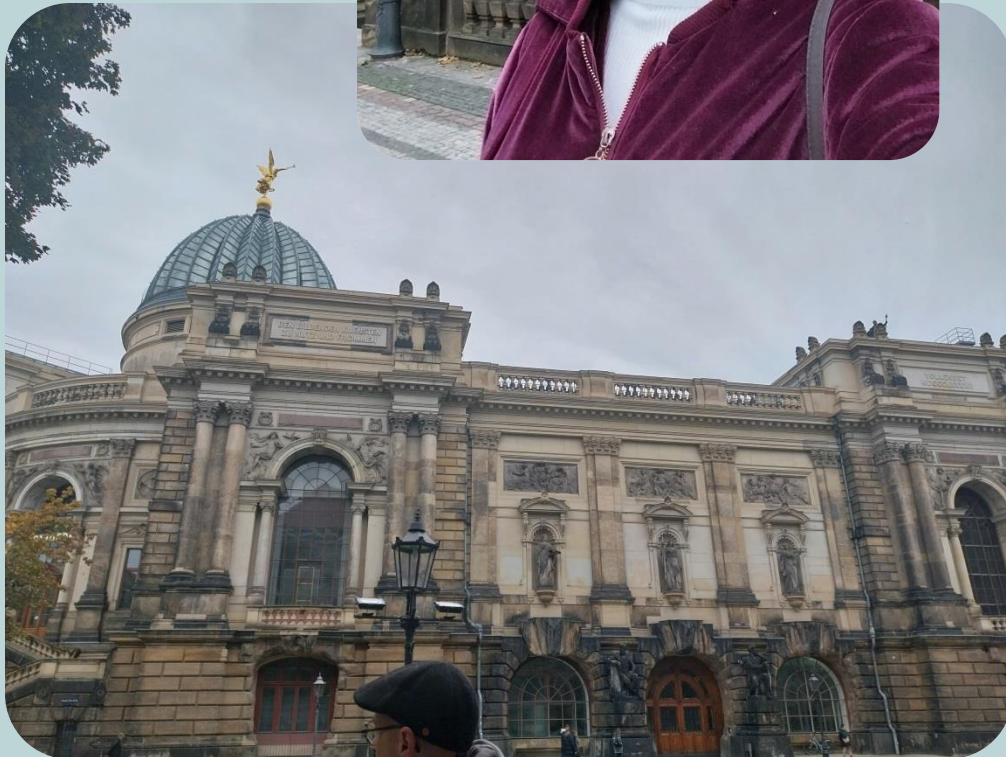

Berlin

**Our weekend trip to Berlin ,
where we visited the city centre
and we also went sightseeing.**

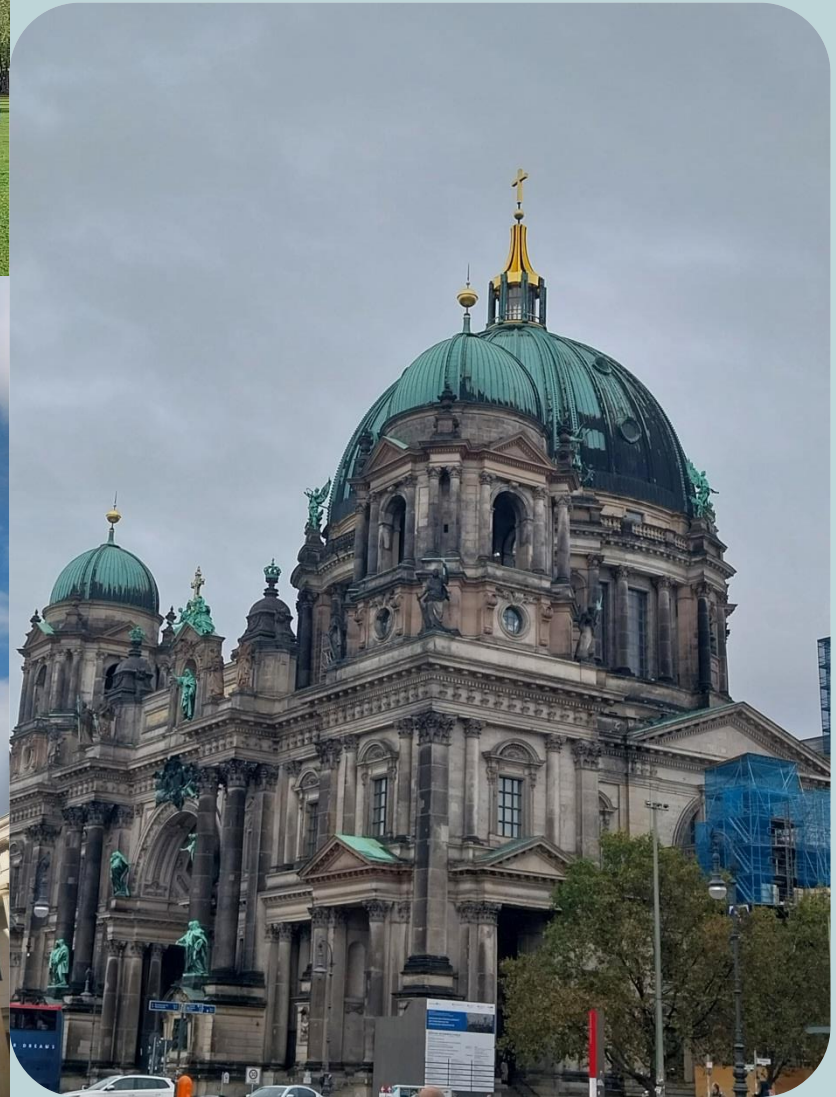

Thank you for everything

Certificate

The Vitalis Team certifies that

Ms. Nina Čúzová, d.o.b. 15.02.2005

participated in the European Erasmus project

“The further development of professional education moves us forward”

with project number 2023-1-SK01-KA122-VET-000124786

from 29.10.2023 to 11.11.2023

Johanna Neumann
Project Management



This project was carried out according to the guidelines
given by the European Commission at
Vitalis Betreuungsgesellschaft für Modellprojekte mbH



Ralf Giesecke
Director of Vitalis GmbH



Erasmus+

Vitalis
Betreuungsgesellschaft für Modellprojekte mbH
Coordination of European Projects in vocational training
VITALIS GmbH, Gut Wehlitz 1, 04435 Schkeuditz
e-mail: info@gutwehlitz.com
Tel. +49 (0) 3 42 04 77 40 00

Certificate

Ms. Nina Čúzová

born on 15.02.2005, participated in the project “The further development of professional education moves us forward” with the project number 2023-1-SK01-KA122-VET-000124786 from 29.10.2023 until 11.11.2023. The participant successfully completed the Electrician internship.

The focus points of the internship were as follows:

- Work with technical documentations and regulations, read technical drawings
- Measurements of installation parameters according to technical documentation
- Production of circuit diagrams and complex circuits (control technology)
- Specifications on cross-sections and necessary protective devices
- Cutting, trimming and correct wiring in junction boxes and power distributors
- Designing schematics for professional documentation
- Measurement voltage, protective conductor resistance, insulation resistance, tripping time and tripping current from RCD

Assembly of switches, push buttons, socket outlets, relays

Use of monostable and bistable relays, time relays, multifunction: clock delay), transformer and bell system

The participants were introduced to professional standard operating procedures and regulations as well as information about health and safety measures and accident prevention.

As a professional and a team member, Nina Čúzová has:

an excellent willingness to work enthusiastically with others, to seek clarification through questions, to use resources and accept feedback and responsibility.

an excellent willingness to listen, to share ideas with others, to speak with respect and curiosity and to be open to the audience.

an excellent willingness and ability to follow instructions and complete assigned tasks, to work independently and seek help when needed, to take initiative and to be able to reflect on and improve their work.

an excellent ability to see and describe a problem, to make connections with prior learning, collect and analyze evidence to understand a problem, a willingness to experiment with new techniques and approaches and an ability to review a solution and improve it.

an excellent ability to be on time and prepared for work, to know and do what is right and fair, to work with a positive attitude toward continuous improvement and to respond well to feedback and constructive criticism.

Nina Čúzová for participating and wish them all the best and much success for their professional and personal future.

11.11.2023

Project Management

VITALIS
Institute for the supervision
of model projects Ltd.
Gut Wehlitz 04435 Schkeuditz
Germany
phone: +49 3 42 04 77 40 21
e-mail: leonardos@gut-wehlitz.de